



Published Manual Number/ECN: MKWXBH01U1/2022036A

- Publishing System: TPAS2
- Access date: 01/14/2022
- Document ECNs: Latest

36026X8R

42026 & 42032X7R



MKWXBH01U1/22036A

1. English

Maintenance Guide - Washer-extractor, Top-suspended,
Grease Bearings, _X7R, _X8R

MKWXBH01EN/2021444

English

1



Manual Number: MKWXBH01EN
Edition (ECN): 2021444

Maintenance Guide

Washer-extractor, Top-suspended, Grease Bearings, _X7R, _X8R



Contents

1 Machine Description and Identification	4
1.1 About This Manual and Your Milnor® Machine	4
1.1.1 Description	4
1.1.2 Machine Identification.....	4
• Machine Data Plate	4
2 Safety.....	5
2.1 Safety — Suspended Washer Extractors	5
2.1.1 Safety Alert Messages—Internal Electrical and Mechanical Hazards.....	5
2.1.2 Safety Alert Messages—Cylinder and Processing Hazards.....	5
2.1.3 Safety Alert Messages—Unsafe Conditions	7
2.1.3.1 Damage and Malfunction Hazards	7
2.1.3.1.1 Hazards Resulting from Inoperative Safety Devices.....	7
2.1.3.1.2 Hazards Resulting from Damaged Mechanical Devices	7
2.1.3.2 Careless Use Hazards	8
2.1.3.2.1 Careless Operation Hazards—Vital Information for Operator Personnel (see also operator hazards throughout manual)	8
2.1.3.2.2 Careless Servicing Hazards—Vital Information for Service Personnel (see also service hazards throughout manuals).....	8
2.2 Prevent Damage from Chemical Supplies and Chemical Systems	9
2.2.1 How Chemical Supplies Can Cause Damage.....	9
• Dangerous Chemical Supplies and Wash Formulas.....	9
• Incorrect Configuration or Connection of Equipment	10
2.2.2 Equipment and Procedures That Can Prevent Damage.....	12
• Use the chemical manifold supplied.	12
• Close the line.....	13
• Do not let a vacuum occur.....	13
• Flush the chemical tube with water.....	13
• Put the chemical tube fully below the inlet.....	13
• Prevent leaks.	13
3 Routine Maintenance.....	14
3.1 Routine Maintenance	14
3.1.1 Maintenance Summary	14
3.1.1.1 Guards and Related Components	15
3.1.1.2 Filters, Screens, and Sensitive Components.....	15
3.1.1.3 Components that Become Worn.....	16
3.1.1.4 Bearings and Bushings	16
3.1.1.5 Motor Grease Schedule	16
3.1.1.6 Mechanisms and Settings	17
3.1.2 How To Remove Contamination	17
3.1.3 Lubricant Identification	18
3.1.4 Grease Gun Procedures	19
3.1.5 Procedures for Bearing Components Connected to a Grease Plate.....	19
3.1.6 Procedures for Motors	20
3.1.7 How To Show the Maintenance On a Calendar	22
3.2 Maintenance Components—Machines and Controls Group	23
3.2.1 How to Examine V-belts and Pulleys	23

3.2.2 Inverters.....	25
3.2.3 Chemical Devices.....	25
3.2.4 Water and Steam Devices.....	26
3.2.5 How to Examine Compressed Air Mechanisms.....	28
3.2.6 How to Do a Test of Emergency Stop Mechanisms.....	30
3.3 Maintenance Components—Large Extractors	32
3.3.1 Lubricant Maintenance for Grease-filled Drive Bearings.....	32
3.3.2 About the Shock Absorbers.....	32

Figures

Figure 1	Machine Data Plate.....	4
Figure 2	Incorrect Configurations That Let the Chemical Supply Go In the Machine by a Siphon.....	11
Figure 3	Incorrect Configurations That Let the Chemical Supply Go In the Machine by Gravity.....	12
Figure 4	Examples of Manifolds for Chemical Tubes. Your equipment can look different.....	12
Figure 5	A Configuration that Prevents Flow in the Machine When the Pump is Off (if the chemical tube and tank have no pressure).....	13
Figure 6	Motor Grease Maintenance Conditions	21
Figure 7	Belt and Pulley Conditions To Look For	23
Figure 8	How to Adjust Belt Tension On a Machine That Uses Spring Tension	24
Figure 9	Electric Box and Inverter. These are examples. Your machine can look different.....	25
Figure 10	Chemical Inlet Manifolds for Chemical Pump Systems. See caution statement below. These are examples. Your machine can look different.	26
Figure 11	Soap Chute and Optional 5-compartment Supply Injector. These are examples. Your machine can look different.	26
Figure 12	Air Tube for the Water Level Sensor. These are examples. Your machine can look different.	27
Figure 13	Water Pressure Regulator for Chemical Flush. These are examples. Your machine can look different.....	27
Figure 14	Steam Inlet Strainer. These are examples. Your machine can look different.....	28
Figure 15	Compressed Air Inlet Strainers. These are examples. Your machine can look different.....	28
Figure 16	Self-purging Air Line Filter to Remove Moisture and Other Contamination. These are examples. Your machine can look different.....	29
Figure 17	Compressed Air Mechanisms These are examples. Your machine can look different.	30
Figure 18	Grease Ports for Grease-only Bearing Assembly	32
Figure 19	Suspension Components on Each Side of Rubber Spring-Hung Washer-extractors.....	33

Tables

Table 1	Guards and Related Components	15
---------	-------------------------------------	----

Table 2	Filters, Screens, and Sensitive Components	15
Table 3	Components that Become Worn	16
Table 4	Bearings and Bushings	16
Table 5	Motor Grease Schedule	16
Table 6	Mechanisms and Settings	17
Table 7	Contamination Types, Cleaning Agents, and Procedures	17
Table 8	Lubricant Identification	18
Table 9	Motor Grease Intervals and Quantities	22
Table 10	Where to Put Marks On a Calendar	23

1 Machine Description and Identification

BNUUUF02 / 2021442

BNUUUF02

0000369288

10/25/21 9:27 AM

Released

1.1 About This Manual and Your Milnor® Machine

BNUUUF02.C01 0000369287 A.6 A.9 10/14/21 8:55 AM Released

This manual applies to two or more models that share the mechanical characteristics stated below. If you received this manual with your machine, your machine is one of the applicable models. However, before using this manual, verify that your machine does have these characteristics.

1.1.1 Description

BNUUUF02.C02 0000369286 A.6 A.35 11/16/21 8:39 AM Released

Washer-extractors wash linen using water and non-volatile chemicals then remove excess water by centrifugal force. This washer-extractor is the mechanical type described below.

36026X8R, 42026X7R or 42032X7R A machines represented by one of these model numbers is a top suspended (rubber springs) washer-extractor with grease bearings. The capacity can be 100 lb (45 kg) to 170 lb.(77 kg) depending on model.

1.1.2 Machine Identification

BNUUUF02.R01 0000369284 A.6 A.9 10/25/21 9:22 AM Released

Machine Data Plate — Find the model number and other data for your machine on the machine data plate affixed to the machine and described below.

Figure 1. Machine Data Plate

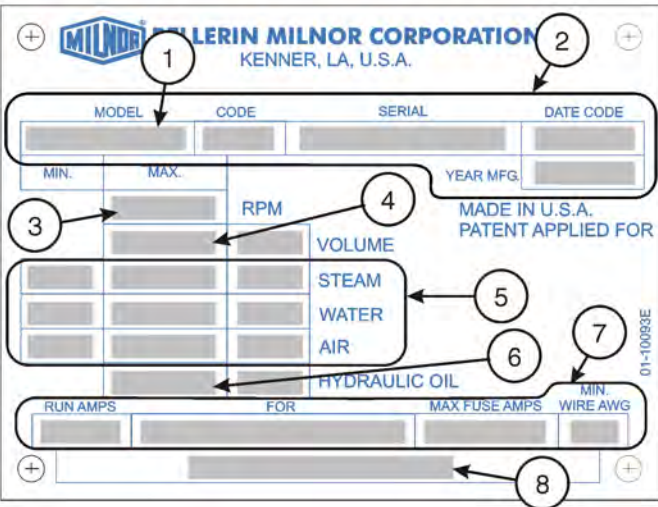
View of Data Plate (English text shown)	Legend
 <p>The diagram shows a data plate for Milner Milnor Corporation. It includes fields for Model, Code, Serial, Date Code, RPM (with Min and Max), Volume (for Steam, Water, Air, and Hydraulic Oil), Year Mfg., Run Amps, Max Fuse Amps, and Wire AWG. Callouts 1-8 identify specific areas: 1 (Model number), 2 (Unique machine identifier), 3 (RPM), 4 (Volume), 5 (Utility requirements), 6 (Hydraulic pressure), 7 (Electrical requirements), and 8 (Part number).</p>	<p>Legend</p> <ol style="list-style-type: none"> 1. Model number. 2. Data that uniquely identifies your machine 3. Cylinder maximum rotation speed in revolutions per minute, if applicable 4. Cylinder volume in the units of measure shown, if applicable 5. Piped utility requirements 6. Hydraulic oil pressure, if applicable 7. Electrical requirements 8. Part number for multi-unit machine, if applicable.

2 Safety

BNWSUS08 / 21224

BNWSUS08 0000348933 A.2 5/26/21 12:00 PM Released

2.1 Safety — Suspended Washer Extractors

BNWSUS08.C01 0000348932 A.6 A.2 5/26/21 11:48 AM Released

2.1.1 Safety Alert Messages—Internal Electrical and Mechanical Hazards

BNWSUS01.C03 0000234965 A.6 A.2 A.4 1/2/20 2:19 PM Released

The following are instructions about hazards inside the machine and in electrical enclosures.



WARNING: Electrocutation and Electrical Burn Hazards — Contact with electric power can kill or seriously injure you. Electric power is present inside the cabinetry unless the main machine power disconnect is off.



- ▶ Do not unlock or open electric box doors.
- ▶ Do not remove guards, covers, or panels.
- ▶ Do not reach into the machine housing or frame.
- ▶ Keep yourself and others off of machine.
- ▶ Know the location of the main machine disconnect and use it in an emergency to remove all electric power from the machine.



WARNING: Entangle and Crush Hazards — Contact with moving components normally isolated by guards, covers, and panels, can entangle and crush your limbs. These components move automatically.



- ▶ Do not remove guards, covers, or panels.
- ▶ Do not reach into the machine housing or frame.
- ▶ Keep yourself and others off of machine.
- ▶ Know the location of all emergency stop switches, pull cords, and/or kick plates and use them in an emergency to stop machine motion.

2.1.2 Safety Alert Messages—Cylinder and Processing Hazards

BNWSUS03.C03 0000234973 A.6 A.2 A.3 1/2/20 2:19 PM Released

The following are instructions about hazards related to the cylinder and laundering process.



DANGER: **Entangle and Sever Hazards** — Contact with goods being processed can cause the goods to wrap around your body or limbs and dismember you. The goods are normally isolated by the locked cylinder door.



- ▶ Do not attempt to open the door or reach into the cylinder until the cylinder is stopped.
- ▶ Do not touch goods inside or hanging partially outside the turning cylinder.
- ▶ Do not operate the machine with a malfunctioning door interlock.
- ▶ Open pocket machines only—Do not jog the cylinder and pull the goods at the same time.
- ▶ Open pocket machines only—Keep yourself and others clear of cylinder and goods during jogging operation.
- ▶ Do not operate the machine with malfunctioning two-hand manual controls.
- ▶ Know the location of all emergency stop switches, pull cords, and/or kick plates and use them in an emergency to stop machine motion.
- ▶ Know the location of the main machine disconnect and use it in an emergency to remove all electric power from the machine.



WARNING: **Crush Hazards** — Contact with the turning cylinder can crush your limbs. The cylinder will repel any object you try to stop it with, possibly causing the object to strike or stab you. The turning cylinder is normally isolated by the locked cylinder door.



- ▶ Do not attempt to open the door or reach into the cylinder until the cylinder is stopped.
- ▶ Do not place any object in the turning cylinder.
- ▶ Do not operate the machine with a malfunctioning door interlock.
- ▶ Open pocket machines only—Keep yourself and others clear of cylinder and goods during jogging operation.
- ▶ Do not operate the machine with malfunctioning two-hand manual controls.



WARNING: **Confined Space Hazards** — Confinement in the cylinder can kill or injure you. Hazards include but are not limited to panic, burns, poisoning, suffocation, heat prostration, biological contamination, electrocution, and crushing.



- ▶ Do not attempt unauthorized servicing, repairs, or modification.



WARNING: **Explosion and Fire Hazards** — Flammable substances can explode or ignite in the cylinder, drain trough, or sewer. The machine is designed for washing with water, not any other solvent. Processing can cause solvent-containing goods to give off flammable vapors.



- ▶ Do not use flammable solvents in processing.

- ▶ Do not process goods containing flammable substances. Consult with your local fire department/public safety office and all insurance providers.

2.1.3 Safety Alert Messages—Unsafe Conditions

BNWSUS04.C01 0000235002 A.6 A.2 A.3 12/10/20 4:36 PM Released

2.1.3.1 Damage and Malfunction Hazards

BNWSUS04.C02 0000235001 A.6 A.2 A.3 12/10/20 4:36 PM Released

2.1.3.1.1 Hazards Resulting from Inoperative Safety Devices

BNWSUS04.C03 0000235000 A.6 A.2 12/10/20 4:36 PM Released



DANGER: Entangle and Sever Hazards — Cylinder door interlock—Operating the machine with a malfunctioning door interlock can permit opening the door when the cylinder is turning and/or starting the cycle with the door open, exposing the turning cylinder.



- ▶ Do not operate the machine with any evidence of damage or malfunction.



WARNING: Multiple Hazards — Operating the machine with an inoperative safety device can kill or injure personnel, damage or destroy the machine, damage property, and/or void the warranty.

- ▶ Do not tamper with or disable any safety device or operate the machine with a malfunctioning safety device. Request authorized service.



WARNING: Electrocution and Electrical Burn Hazards — Electric box doors—Operating the machine with any electric box door unlocked can expose high voltage conductors inside the box.



- ▶ Do not unlock or open electric box doors.



WARNING: Entangle and Crush Hazards — Guards, covers, and panels—Operating the machine with any guard, cover, or panel removed exposes moving components.



- ▶ Do not remove guards, covers, or panels.

2.1.3.1.2 Hazards Resulting from Damaged Mechanical Devices

BNWSUS04.C04 0000234999 A.6 A.2 A.4 12/10/20 4:36 PM Released



WARNING: Multiple Hazards — Operating a damaged machine can kill or injure personnel, further damage or destroy the machine, damage property, and/or void the warranty.

- ▶ Do not operate a damaged or malfunctioning machine. Request authorized service.



WARNING: Explosion Hazards — Cylinder—A damaged cylinder can rip apart during extraction, puncturing the shell and discharging metal fragments at high speed.



- ▶ Do not operate the machine with any evidence of damage or malfunction.



WARNING: Explosion Hazards — Clutch and speed switch (multiple motor machines)—A damaged clutch or speed switch can permit the low speed motor to engage during extract. This will over-speed the motor and pulleys and can cause them to rip apart, discharging metal fragments at high speed.



- ▶ Stop the machine immediately if any of these conditions occur:
 - abnormal whining sound during extract
 - skidding sound as extract ends
 - clutches remain engaged or re-engage during extract

2.1.3.2 Careless Use Hazards

BNWSUS04.C05 0000234998 A.6 A.2 A.3 12/10/20 4:36 PM Released

2.1.3.2.1 Careless Operation Hazards—Vital Information for Operator Personnel (see also operator hazards throughout manual)

BNWSUS04.C06 0000234997 A.6 A.2 A.4 12/10/20 4:36 PM Released



WARNING: Multiple Hazards — Careless operator actions can kill or injure personnel, damage or destroy the machine, damage property, and/or void the warranty.

- ▶ Do not tamper with or disable any safety device or operate the machine with a malfunctioning safety device. Request authorized service.
- ▶ Do not operate a damaged or malfunctioning machine. Request authorized service.
- ▶ Do not attempt unauthorized servicing, repairs, or modification.
- ▶ Do not use the machine in any manner contrary to the factory instructions.
- ▶ Use the machine only for its customary and intended purpose.
- ▶ Understand the consequences of operating manually.

2.1.3.2.2 Careless Servicing Hazards—Vital Information for Service Personnel (see also service hazards throughout manuals)

BNWSUS04.C07 0000234996 A.6 A.2 A.4 12/10/20 4:36 PM Released



WARNING: Electrocution and Electrical Burn Hazards — Contact with electric power can kill or seriously injure you. Electric power is present inside the cabinetry unless the main machine power disconnect is off.



- ▶ Do not service the machine unless qualified and authorized. You must clearly understand the hazards and how to avoid them.
- ▶ Abide by the current OSHA lockout/tagout standard when lockout/tagout is called for in the service instructions. Outside the USA, abide by the OSHA standard in the absence of any other overriding standard.



WARNING: Entangle and Crush Hazards — Contact with moving components normally isolated by guards, covers, and panels, can entangle and crush your limbs. These components move automatically.



- ▶ Do not service the machine unless qualified and authorized. You must clearly understand the hazards and how to avoid them.
- ▶ Abide by the current OSHA lockout/tagout standard when lockout/tagout is called for in the service instructions. Outside the USA, abide by the OSHA standard in the absence of any other overriding standard.



WARNING: Confined Space Hazards — Confinement in the cylinder can kill or injure you. Hazards include but are not limited to panic, burns, poisoning, suffocation, heat prostration, biological contamination, electrocution, and crushing.



- ▶ Do not enter the cylinder until it has been thoroughly purged, flushed, drained, cooled, and immobilized.

BIWUUI03 / 2019296

BNUUUR02 0000160550 E.3 1/2/20 2:14 PM Released

2.2 Prevent Damage from Chemical Supplies and Chemical Systems

BNUUUR02.C01 0000160549 A.6 E.3 B.3 1/2/20 2:14 PM Released

All Milnor® washer-extractors and CBW® tunnel washers use stainless steel with the ANSI 304 specification. This material gives good performance when chemical supplies are correctly applied. If chemical supplies are incorrectly applied, this material can be damaged. The damage can be very bad and it can occur quickly.

Chemical supply companies usually:

- supply chemical pump systems that put the supplies in the machine,
- connect the chemical pump system to the machine,
- write wash formulas that control the chemical concentrations.

The company that does these procedures must make sure that these procedures do not cause damage. **Pellerin Milnor Corporation accepts no responsibility for chemical damage to the machines it makes or to the goods in a machine.**

2.2.1 How Chemical Supplies Can Cause Damage

BNUUUR02.R01 0000160548 A.6 E.3 B.5 10/1/21 11:24 AM Released

Dangerous Chemical Supplies and Wash Formulas — Some examples that can cause damage are:

- a very high concentration of chlorine bleach,
- a mixture of acid sour and hypo chlorite,
- chemical supplies (examples: chlorine bleach, hydrofluosilicic acid) that stay on the stainless steel because they are not quickly flushed with water.

The book “Textile Laundering Technology” by Charles L. Riggs gives data about correct chemical supplies and formulas.

Incorrect Configuration or Connection of Equipment — Many chemical systems:

- do not prevent a vacuum in the chemical tube (for example, with a vacuum breaker) when the pump is off,
- do not prevent flow (for example, with a valve) where the chemical tube goes in the machine.

Damage will occur if a chemical supply can go in the machine when the chemical system is off. Some configurations of components can let the chemical supplies go in the machine by a siphon ([Figure 2, page 11](#)). Some can let chemical supplies go in the machine by gravity ([Figure 3, page 12](#)).

Figure 2. Incorrect Configurations That Let the Chemical Supply Go In the Machine by a Siphon

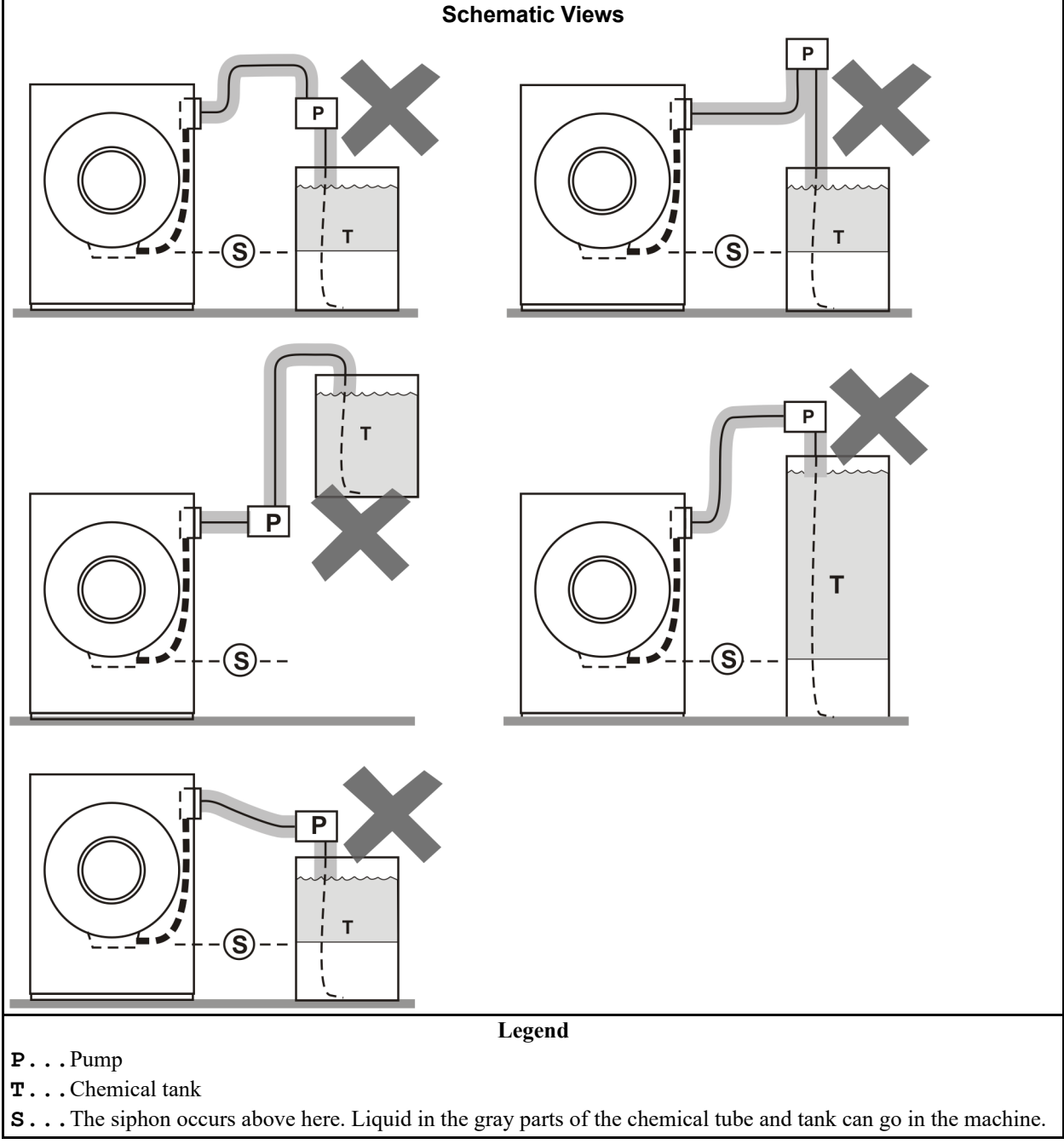
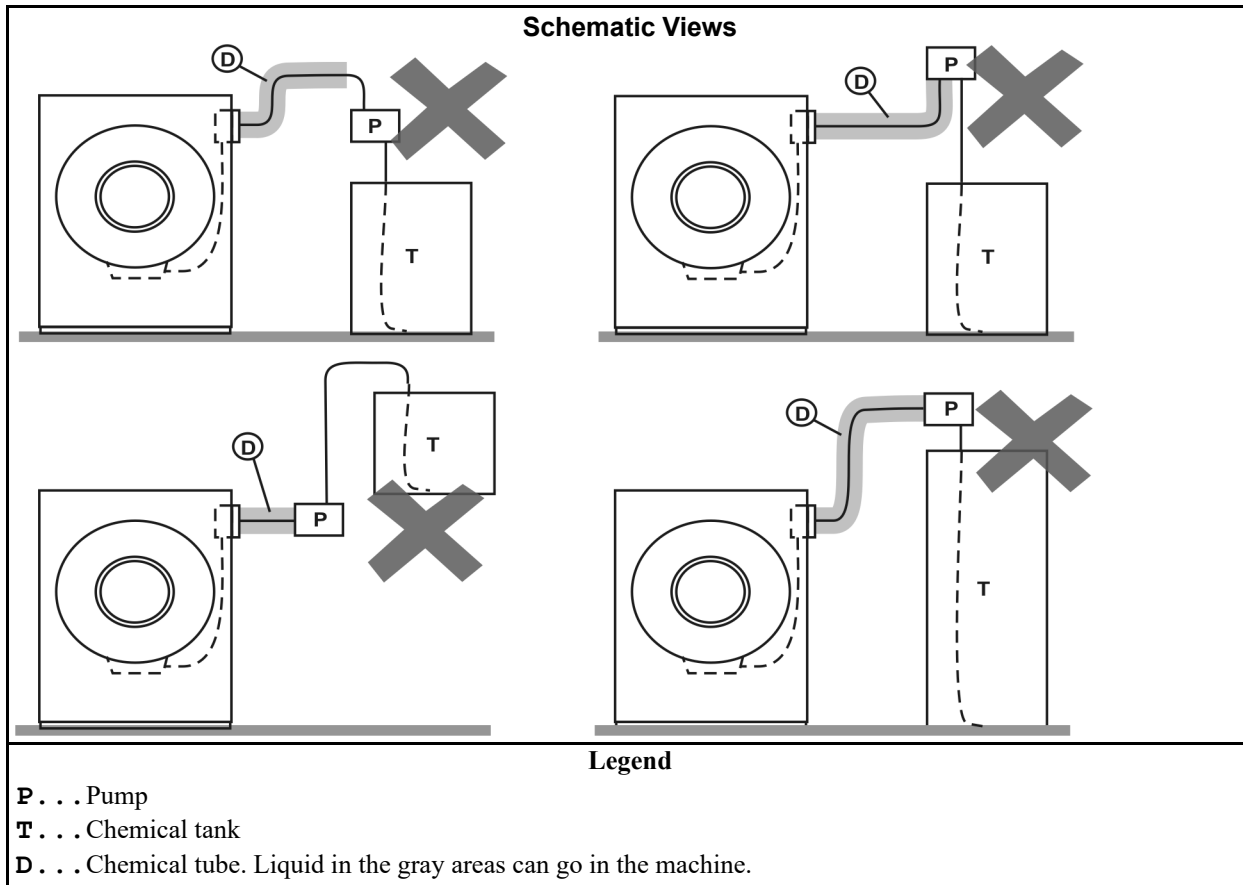

Figure 3. Incorrect Configurations That Let the Chemical Supply Go In the Machine by Gravity



2.2.2 Equipment and Procedures That Can Prevent Damage

BNUUUR02.R02 0000160545 A.6 E.3 B.3 1/2/20 2:14 PM Released

Use the chemical manifold supplied. — There is a manifold on the machine to attach chemical tubes from a chemical pump system. The manifold has a source of water to flush the chemical supplies with water.

Figure 4. Examples of Manifolds for Chemical Tubes. Your equipment can look different.

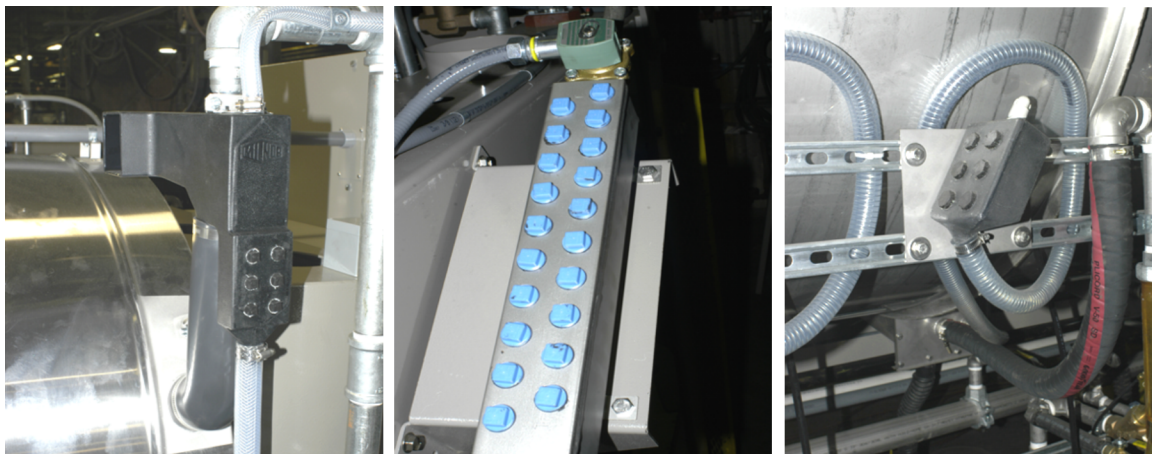

Close the line. — If the pump does not always close the line when it is off, use a shutoff valve to do this.

Do not let a vacuum occur. — Supply a vacuum breaker in the chemical line that is higher than the full level of the tank.

Flush the chemical tube with water. — If the liquid that stays in the tube between the pump and the machine can flow in the machine, flush the tube with water after the pump stops.

Put the chemical tube fully below the inlet. — It is also necessary that there is no pressure in the chemical tube or tank when the system is off.

Figure 5. A Configuration that Prevents Flow in the Machine When the Pump is Off (if the chemical tube and tank have no pressure)

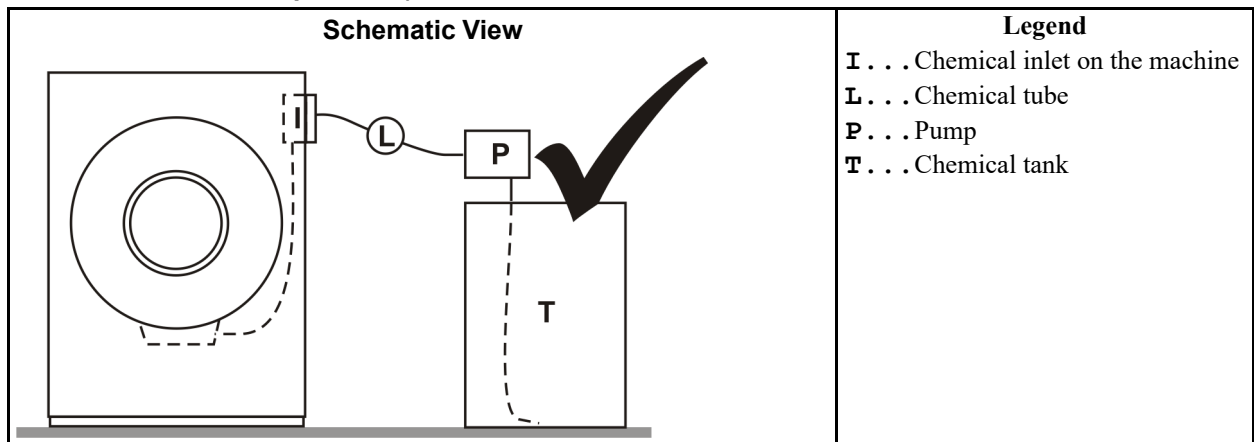

Prevent leaks. — When you do maintenance on the chemical pump system:

- Use the correct components.
- Make sure that all connections are the correct fit.
- Make sure that all connections are tight.

3 Routine Maintenance

BNUUUH01 / 2021444

BNUUUH01 0000333813 A.26 11/4/21 9:18 AM Released

3.1 Routine Maintenance

BIUUUM09.C01 A.6 A.26 Released

Do the maintenance in [Section 3.1.1 : Maintenance Summary, page 14](#) to make sure that the machine is safe, keeps the warranty, and operates correctly. This will also decrease repair work and unwanted shutdowns. Speak to your dealer or the Milnor® Service department if repairs are necessary.



WARNING: Mechanisms — can pull in and mutilate body parts.



- ▶ Do not service the machine unless qualified and authorized. You must clearly understand the hazards and how to avoid them.
- ▶ Do not service the machine with power on except when explicitly called for in the service instructions. Use extreme care when working near moving components.
- ▶ Replace guards and covers that you remove for maintenance.

If you use software to keep the maintenance schedule for your plant, add the items in the following maintenance summary to that schedule. If not, you can put marks on a calendar that work with the tables in the maintenance summary. See [Section 3.1.7 : How To Show the Maintenance On a Calendar, page 22](#)

3.1.1 Maintenance Summary

BNUUUH01.R02 0000334004 A.6 A.26 A.35 10/25/21 1:20 PM Released

Each of the following sections is for a type of maintenance. For example, the section “Guards and Related Components” says “Examine these items. If an item is damaged, missing, or has the wrong setting, correct this discrepancy immediately to prevent injury.” A table in each section identifies the applicable items and the frequency. The “More Data” column gives special instructions if necessary.

* If the machine operates more than 12 hours each day, do the “day” items two times each day. Do the other items at the given hours or on the days that you show on a calendar (see Section 1). **Do all items in all sections for the maintenance intervals that apply (for example, day, 40 to 60 hours, and 200 hours).**



TIP: The maintenance summary has many links to the sections that follow the summary. These sections give more information about the maintenance items. After you learn this information, it is only necessary to look at the summary to do the maintenance.

3.1.1.1 Guards and Related Components

BNUUUH01.R09 0000399322 A.6 A.26 A.9 11/4/21 11:27 AM Released

Examine these items. If an item is damaged, missing, or has the wrong setting, correct this discrepancy immediately to prevent injury.

Table 1. Guards and Related Components

Mark						Do this each	Component	More Data
1	2	3	4	5	6			
x						day*	guards, covers	Speak to your dealer or Milnor for replacement components.
x						day*	safety placards	
		x				200 hours	fasteners	Fasteners must be tight.
		x				200 hours	anchor bolts and grout	Grout must be good. Bolts must be tight.
x						day*	door interlock	If the machine operates with the door open: <ul style="list-style-type: none"> • Immediately remove power. • Do not permit operation. • Speak to your dealer or Milnor.
x						day*	emergency stop button (optional on some washer-extractors)	See Section 3.2.6 , page 30. Do a test of the control.

3.1.1.2 Filters, Screens, and Sensitive Components

BNUUUH01.R10 0000399352 A.6 A.26 A.19 11/16/21 10:29 AM Released

Remove contamination from these items to prevent damage and unsatisfactory performance.

Table 2. Filters, Screens, and Sensitive Components

Mark						Do this each	Component	More Data. See also Section 3.1.2 , page 17
1	2	3	4	5	6			
	x					40 to 60 hours	inverter fans, vents, filters	See Figure 9 , page 25. Keep good air flow.
			x			600 hours	motors	Keep good air flow.
					x	2400 hours	entire machine	Remove excessive dust and dirt.
x						day*	chemical inlet areas	Some chemical supplies that stay on machine surfaces will cause corrosion damage. See Section 3.2.3 , page 25 and Section 3.1.2 , page 17. See also, Section 2.2 , page 9 for background information.
		x				200 hours	strainer(s) for air inlet	See Figure 15 , page 28
					x	2400 hours	water inlet strainers if supplied by others	Remove strainers from incoming water lines and flush with water.
					x	2400 hours	strainer in water regulator for optional supply injector and pumped chemicals on some models.	See Figure 11 , page 26
		x				200 hours	strainer for steam inlet. (Steam is optional on some models.)	See Figure 14 , page 28

3.1.1.3 Components that Become Worn

BNUUUH01.R12 0000399389 A.6 A.26 A.23 11/16/21 11:00 AM Released

Examine these items. Tighten or replace the item if necessary, to prevent shutdowns and unsatisfactory performance. Speak to your dealer for replacement parts.

Table 3. Components that Become Worn

Mark						Do this each	Component	More Data
1	2	3	4	5	6			
		x				200 hours	drive belts and pulleys	See Section 3.2.1 , page 23
		x				200 hours	tubes and hoses (non-hydraulic)	Examine hoses and hose connections for leaks.
		x				200 hours	rubber springs	See Figure 19 , page 33
		x				200 hours	shock absorbers	See Section 3.3.2 , page 32

3.1.1.4 Bearings and Bushings

BNUUUH01.R13 0000399388 A.6 A.26 11/16/21 11:04 AM Released

Unless the item is sealed, apply grease to prevent damage. See the next section for motors.

Table 4. Bearings and Bushings

Mark						Do this each	Component	More Data . See also Section 3.1.3 , page 18
1	2	3	4	5	6			
Grease plate 01 10025Z for bearing housing. Use this data if your machine has this grease plate. See Figure 18 , page 32 and Section 3.1.5 : Procedures for Bearing Components Connected to a Grease Plate , page 19. It is necessary to remove a side panel on some models, to access this grease plate.								
		x				200 hours	seal	Add 0.06 oz. (1.8 mL) of grease EPLF2 (Table 8 , page 18)
		x				200 hours	rear bearing	Add 0.12 oz. (3.6 mL) of grease EPLF2
		x				200 hours	front bearing	Add 0.12 oz. (3.6 mL) of grease EPLF2
Other Grease Ports								
		x				200 hours	ball bushings on suspension shafts	Figure 19 , page 33. Add 0.06 oz. (1.8 mL) of grease EPLF2 (Table 8 , page 18).
			x			600 hours	motor and pump bearings	See Section 3.1.6 : Procedures for Motors , page 20

3.1.1.5 Motor Grease Schedule

BNUUUH01.R15 0000399408 A.6 A.26 A.5 10/21/21 10:14 AM Released

Use the data in [Table 9: Motor Grease Intervals and Quantities](#), page 22 to complete this table.

Table 5. Motor Grease Schedule

Motor Identification (example: main drive)	Interval		Quantity		Dates When Grease is Added							
	Years	Hours	fl oz	mL								

3.1.1.6 Mechanisms and Settings

BNUUUH01.R14 0000399409 A.6 A.26 A.11 11/16/21 11:14 AM Released

Make sure mechanisms are serviceable and settings are correct to prevent unsatisfactory performance.

Table 6. Mechanisms and Settings

Mark						Do this each	Component	More Data
1	2	3	4	5	6			
					x	2400 hours	controller circuitry	Examine wiring and connections in electrical boxes. Look for corrosion, loose connections. See Section 3.1.2 , page 17
		x				200 hours	water pressure regulator for optional supply injector	See Figure 11, page 26 . Value: 28 PSI (193 kPa).
		x				200 hours	water pressure regulator for chemical flush	See Figure 13, page 27 . Value: 28 PSI (193 kPa).
		x				200 hours	bath level sensor that uses air pressure	Examine the air tube and connections. See Figure 12, page 27

3.1.2 How To Remove Contamination

BNUUUH01.R03 0000335794 A.6 A.26 A.2 2/18/21 10:13 AM Released

Table 7. Contamination Types, Cleaning Agents, and Procedures

Material or Component	Usual Contamination	Example	Cleaning Agent	More Data
machine housing	dust, dirt	—	compressed air or shop vacuum	Air—no more than 30 psi (207 kpa). Do not push dust in mechanisms.
fans and vents on electrical components	dust	motors, inverters, braking resistors	shop vacuum, soft bristle brush, canned air for electrical components	Do not push dust in mechanisms.
electric box interior	dust	all electric boxes		
electrical connections	corrosion, varnish	spade connector, molex connector, plug-in relay	spray solvent for electrical components	Disconnect then connect it again. Use solvent if the bad connection continues.
electronic sensors	dust	photoeye lens, reflector, laser, proximity switch, temperature probe	none	Use a clean, soft, dry cloth.
	dirt		warm water with soap, then water flush	Use clean, soft cloths.
stainless steel	chemical spill	shell, supply injector	water	Use a hose to flush the chemical supply from the surface fully. Do not get water on electrical components or mechanisms.
300 series stainless steel	chemical corrosive attack	shell interior, cylinder	pickling and passivation	Speak to your dealer or Milnor. This is not routine maintenance.
painted metal, unpainted aluminum	dust, dirt, grease	frame members	warm water with soap, then water to flush	Use clean cloths. Do not get water in electrical components.
rubber	dirt, oil, grease	drive belts, hoses	warm water with soap, then water to flush	Use clean cloths. Flush fully. Oil or soap must not stay on drive belts. Make sure that drive belts are serviceable.

Table 7 Contamination Types, Cleaning Agents, and Procedures (cont'd.)

Material or Component	Usual Contamination	Example	Cleaning Agent	More Data
clear plastic, acrylic	discoloration (yellowing)	compressed air filter bowl, visual flow meter	warm water with soap, then water to flush, then acrylic cleaner. Do not use ammonia.	Use only the necessary cleaning agents. Wash and rinse with clean, soft cloths. Follow instructions on acrylic cleaner.
glass	discoloration (yellowing)	door glass, site glass	ammonia and water solution and water rinse then acetone	Use clean, soft cloths. Use only the necessary cleaning agents. If necessary, soak in cleaner.
soft air filter, lint filter,	dust, lint	on inverter electric box door, in air line filter bowl, in dryers	shop vacuum	Replace the used with a new filter when the vacuum cannot remove contamination.
rigid strainers, screens for water, steam	mineral particles	in water line, y-strainer	water	Use a rigid bristle brush. Flush with a flow of water.
rigid strainers, screens for oil	metal shavings	in hydraulic line	carburetor cleaner or equivalent solvent	Soak. Use a rigid bristle brush.
steel drive components	dirt, hardened lubricant	bearings, roller chains, sprockets, gears	carburetor cleaner or equivalent solvent	Soak. Use a cloth or soft bristle brush.

3.1.3 Lubricant Identification

BNUUUH01.R04 0000335793 A.6 A.26 A.13 11/8/21 11:43 AM Released

The table below identifies the lubricant for each lubricant code given in the maintenance summary. Get these or equivalent lubricants from your local lubricant supplier.

When you add grease, always use the procedures given in [Section 3.1.4 : Grease Gun Procedures, page 19](#). When you add grease to motors, also use the procedures given in [Section 3.1.6 : Procedures for Motors, page 20](#).



CAUTION: **Bad lubricant** — will decrease the life of components.



- ▶ Make sure that all equipment and fittings used to apply lubricants are clean.
- ▶ Use only the given lubricants or equivalent lubricants that have the same specifications.

Table 8. Lubricant Identification

Code	Type	Trademark Name	Application Example
EM	grease	Mobil Polyrex EM or as given on the motor nameplate	motor bearings
EPLF2	grease	Shell Alvania EP (LF) Type 2	drive shaft bearings and bushings, ball joints, chain drives
23	oil	Shell Tellus 23	air line lubricator
1030	oil	Shell Rotella T 10W30	Hydro-cushion™ cylinders
DE3	stick	AGS Door-Ease DE-3	door latch plunger

3.1.4 Grease Gun Procedures

BNUUUH01.R05 0000335825 A.6 A.26 A.3 9/21/21 1:10 PM Released



CAUTION: **Hydraulic pressure** — can push out seals and push grease into unwanted areas (example: motor windings).



- ▶ Use a hand grease gun. A power grease gun gives too much pressure.
- ▶ Know the quantity of grease your grease gun gives each cycle (each stroke).
- ▶ Operate the grease gun slowly (10 to 12 seconds for one cycle).
- ▶ Add only the specified quantity. Stop if new grease come out of a drain port or other opening.
- ▶ Remove spilled grease from belts and pulleys.

The tables give grease quantities in fluid ounces (fl oz) and milliliters (mL). You can also use grease gun cycles (strokes). A cycle is each time that you pull the trigger. One cycle is usually approximately 0.06 fl oz (1.8 mL). Your grease gun can give more or less than this. Measure the output of your grease gun as follows:

- Make sure that the grease gun operates correctly.
- Operate the grease gun to put grease into a small container with fluid ounce or milliliter increments. Pull the trigger fully and slowly.
- Add a sufficient quantity of grease to measure accurately. Count the number of cycles of the grease gun (the number of times that you pull the trigger).
- Calculate the quantity for each cycle of the grease gun, as in the following examples.

Example: 2 fl oz / 64 cycles = 0.031 fl oz for each cycle

Example: 59 mL / 64 cycles = 0.92 mL for each cycle

3.1.5 Procedures for Bearing Components Connected to a Grease Plate

BNUUUH01.R06 0000335824 A.6 A.26 A.3 10/4/21 4:04 PM Released

Your machine has a grease plate on the machine housing or the shell. You add grease to components of the bearing housing at this location. The correct procedure is to add grease when the cylinder turns at wash speed, but obey these precautions:

- For all other grease maintenance, add grease with power removed from the machine.
- If the grease plate on your machine is not serviceable (if you must add grease at a different location), add grease with power removed from the machine.
- If you must remove a guard to get access to the grease plate, prevent access to the machine by other personnel.

If you obey these precautions, use the **Manual** mode to operate the machine at wash speed. Then add grease at the grease plate.

3.1.6 Procedures for Motors

BNUUUH01.R07 0000335823 A.6 A.26 A.7 10/22/21 8:56 AM Released

If a motor on your machine does not have grease fittings, no grease maintenance is necessary. If a motor on your machine has grease fittings, it is necessary to add grease. But the interval is usually longer than for other maintenance. [Table 9: Motor Grease Intervals and Quantities, page 22](#) gives motor grease intervals and quantities for motors with specified frame sizes and speeds. You get this data from the motor nameplate. Use [Table 5: Motor Grease Schedule, page 16](#) to record the data for the motors on your machine.



CAUTION: **Failure to remove grease drain plugs** — can cause grease to enter the windings and burn out the motor.



- ▶ If the motor has grease drain plugs, remove them before you add grease. If the motor has grease relief fittings, it is not necessary to remove them.

Figure 6. Motor Grease Maintenance Conditions

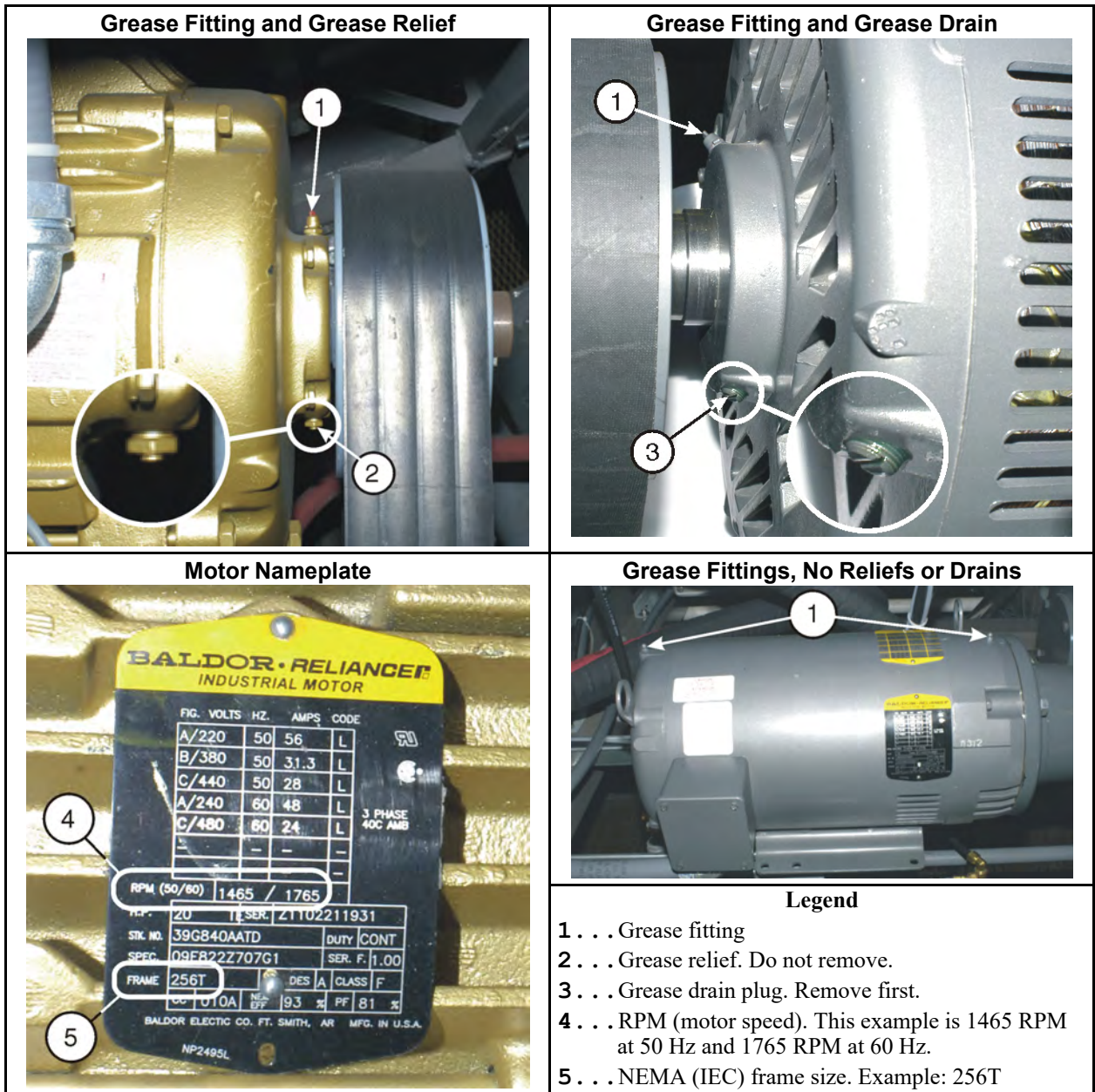

Apply grease as follows:

1. Operate the machine or use manual functions to operate the motor until it is warm.
2. Remove power from the machine.
3. If the motor has grease drain plugs, remove them. See the caution statement above..
4. Add grease EM ([Table 8: Lubricant Identification, page 18](#)) with the motor stopped. If the motor with the nameplate in the above figure operates at 60 Hz, the specified grease quantity for each grease fitting is 0.65 fl oz (18.4 mL).

5. If the motor has a grease drain plugs, operate the machine or use manual functions to operate the motor for two hours. Replace the drain plug.

Table 9. Motor Grease Intervals and Quantities

On Motor Nameplate (see Figure 6: Motor Grease Maintenance Conditions, page 21)		Interval		Quantity	
NEMA (IEC) Frame Size	RPM Less Than or Equal To	Years	Hours	Fluid Ounces	mL
Up to 210 (132)	900	5.5	11000	0.34	9.5
	1200	4.5	9000		
	1800	3	6000		
	3600	1.5	3000		
>210 to 280 (132 to 180)	900	4.5	9000	0.65	18.4
	1200	3.5	7000		
	1800	2.5	5000		
	3600	1	2000		
>280 to 360 (180 to 200)	900	3.5	7000	0.87	24.6
	1200	3	6000		
	1800	2	4000		
	3600	0.5	1000		
>360 to 5000 (200 to 300)	900	2.5	5000	2.23	63.2
	1200	2	4000		
	1800	1	2000		
	3600	0.5	1000		

3.1.7 How To Show the Maintenance On a Calendar

BNUUUH01.R01 0000333958 A.6 A.26 A.5 10/25/21 12:07 PM Released

You can put marks on a calendar that work with the tables in [Section 3.1.1, page 14](#). The marks are the numbers 2, 3, 4, 5, and 6. It is not necessary to show the number 1 (items you do each day) on the calendar. The number 2 = items you do each 40 to 60 hours, 3 = each 200 hours, 4 = each 600 hours, 5 = each 1200 hours, and 6 = each 2400 hours. These are the "Mark" numbers at the top of the narrow columns on the left of each table in [Section 3.1.1, page 14](#).

The table below shows where to put the marks on a calendar. For example, if your machine operates between 41 and 60 hours each week, the first three marks are 2, 2, and 3. Put these marks on the first, second, and third weeks after the machine starts operation. If you do routine maintenance on a given day of the week, put the mark on that day of each week. Continue to put marks on the subsequent weeks. **It can be necessary to do the 40 to 60 hour (2) maintenance more than one time each week.** If the machine operates between 61 and 100 hours, put a 2 on two days of the week. If the machine operates 101 or more hours, put a 2 on three days of the week.

On each date with a 3, do the items with an x in the 3 or the 2 column of each table in [Section 3.1.1, page 14](#). On each date with a 4, do the items with an x in the 4, 3, or 2 column. Continue this pattern.

Table 10. Where to Put Marks On a Calendar

Hours / Week	Week Number																													
	1	2	3	4	5	6	7	8	9	10	11	12	13	14	15	16	17	18	19	20	21	22	23	24	25	26	27	28	29	30
Up to 40	2	2	2	2	3	2	2	2	2	3	2	2	2	2	4	2	2	2	2	3	2	2	2	2	3	2	2	2	2	5
41 - 60	2	2	3	2	2	2	3	2	2	4	2	2	3	2	2	2	3	2	2	5	2	2	3	2	2	2	3	2	2	4
61 - 80	2	2	3	2	3	2	4	2	2	3	2	2	3	2	5	2	3	2	2	3	2	4	2	2	3	2	2	3	2	6
81 - 100	2	3	2	3	2	4	2	3	2	3	2	5	2	3	2	3	2	4	2	3	2	3	2	6	repeat					
101 - 120	2	3	2	3	4	2	3	2	3	5	2	3	2	3	4	2	3	2	3	6	repeat									
121 - 140	2	3	2	3	4	3	2	3	5	2	3	2	3	4	3	2	3	6	repeat											
Hours / Week	Week Number, continued																													
	31	32	33	34	35	36	37	38	39	40	41	42	43	44	45	46	47	48	49	50	51	52	53	54	55	56	57	58	59	60
Up to 40	2	2	2	2	3	2	2	2	2	3	2	2	2	2	4	2	2	2	2	3	2	2	2	2	3	2	2	2	6	
41 - 60	2	2	3	2	2	2	3	2	2	6	repeat																			

BNWUUH01 / 2021444 BNWUUH01 0000335475 B.21 11/16/21 11:16 AM Released

3.2 Maintenance Components—Machines and Controls Group

BNWUUH01.C01 0000335474 A.6 B.21 A.4 6/28/21 3:03 PM Released

3.2.1 How to Examine V-belts and Pulleys

BNWUUH01.C02 0000335471 A.6 B.21 B.4 9/15/21 1:52 PM Released

Figure 7. Belt and Pulley Conditions To Look For

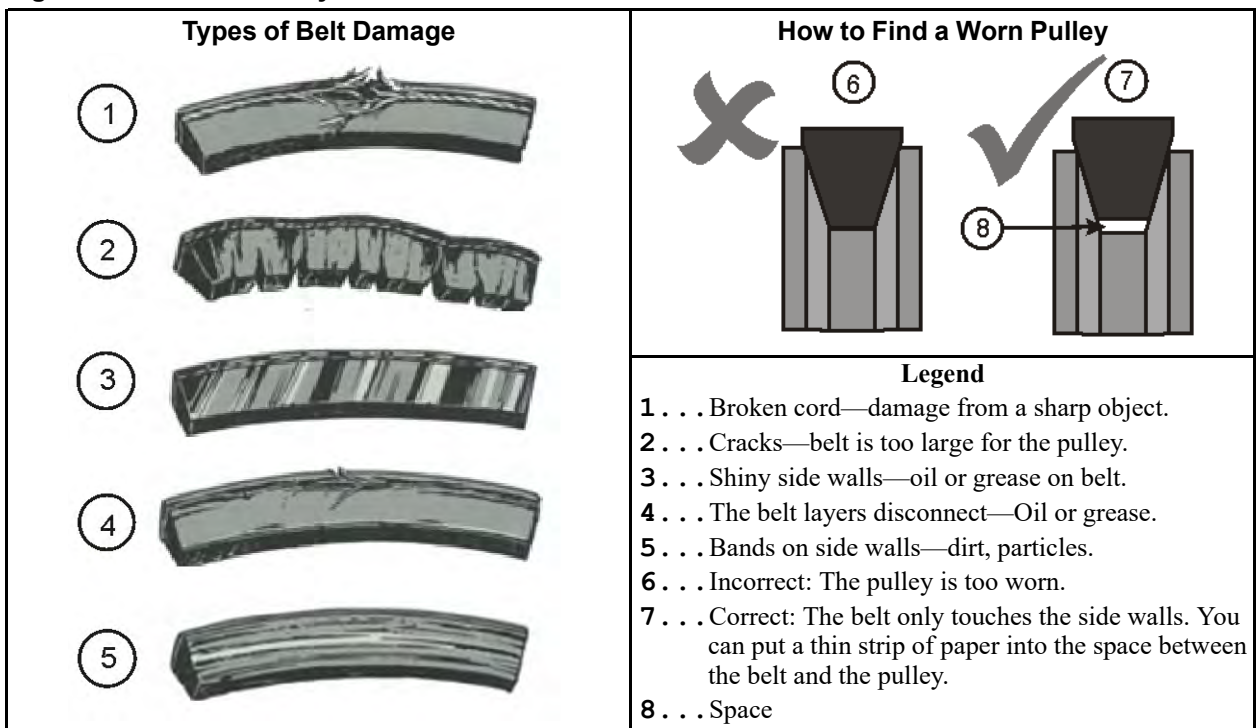

With power removed:

- Look for dirt, dust, oil, and grease. Remove contamination.

- Look for belt damage as shown in the figure above.
- Look for worn pulleys as shown in the figure above.

With the machine in operation—Do not touch the machine. Look and listen:

- A belt can have some vibration and not cause damage. It is necessary to correct this condition only if the vibration is large.
- A belt must have sufficient tension that there is no slippage on the pulley during operation. If slippage occurs, you can usually tell from the noise.

About Component Replacement and Tension Adjustment—Correct adjustment is very important to the service life of components and operation of the machine. Your Milnor® dealer can do this work. If you know how to do this work (for example, correctly align belts and pulleys), and you want to do it, speak to your dealer or Milnor® for part numbers. Replace worn components before you make tension adjustments.

- Machines that use rods with full threads and nuts to hold the position of the motor base—Turn the nuts on the rods as necessary to adjust tension. Tighten the nuts.
- Machines that use a spring to hold tension on the motor base—Use the belt tension sleeve supplied with the machine. Put the sleeve on the rod that the spring is attached to or remove the sleeve to increase or decrease tension (see the figure below). Replace the spring if necessary.

Figure 8. How to Adjust Belt Tension On a Machine That Uses Spring Tension

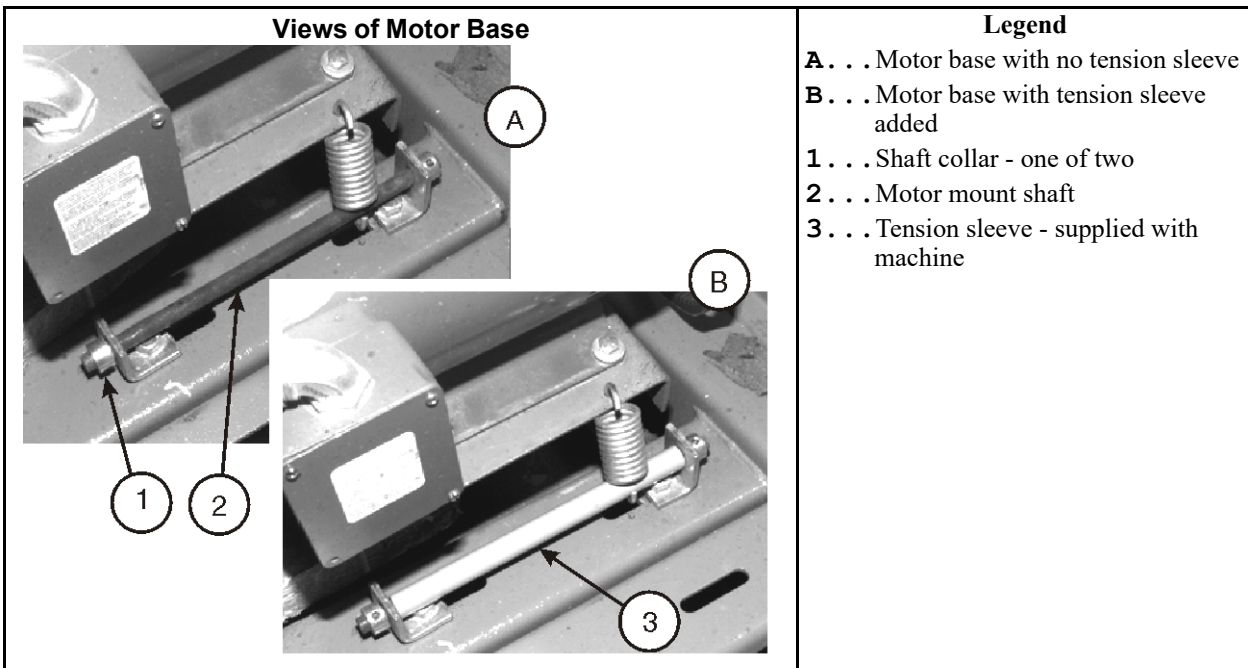

3.2.2 Inverters

BNWUUH01.C08 0000351755 A.6 B.21 A.4 10/12/21 9:38 AM Released



CAUTION: **Insufficient airflow** — will cause the inverter to burn out.

- ▶ Keep fans, filter, vents, and braking resistors clean.

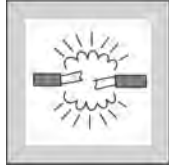

Figure 9. Electric Box and Inverter. These are examples. Your machine can look different.

30022X_ Washer-extractor	48040F_ Washer-extractor	76039 CBW® Tunnel Washer
Legend		
<p>1 . . . Air filter 2 . . . Fan on electric box door. Tip: Put streamers in front of the fan to make sure the fan operates. 3 . . . Inverter cooling vanes and vents. See caution statement below. 4 . . . Braking resistor, if applicable</p>		

3.2.3 Chemical Devices

BNWUUH01.C09 0000351754 A.6 B.21 A.8 10/25/21 2:12 PM Released



CAUTION: **Chemical corrosion** — can damage the machine and the goods.

- ▶ Connect chemical tubes only to chemical manifold inlets.
- ▶ Stop leaks. Remove leaked supplies from surfaces.
- ▶ Speak to your dealer or Milnor® if you see corrosion damage.



CAUTION: **High water pressure** — can cause laundering chemicals to splash on personnel and machine surfaces.

- ▶ Make sure the pressure is set as told in the maintenance summary.



Figure 10. Chemical Inlet Manifolds for Chemical Pump Systems. See caution statement below. These are examples. Your machine can look different.

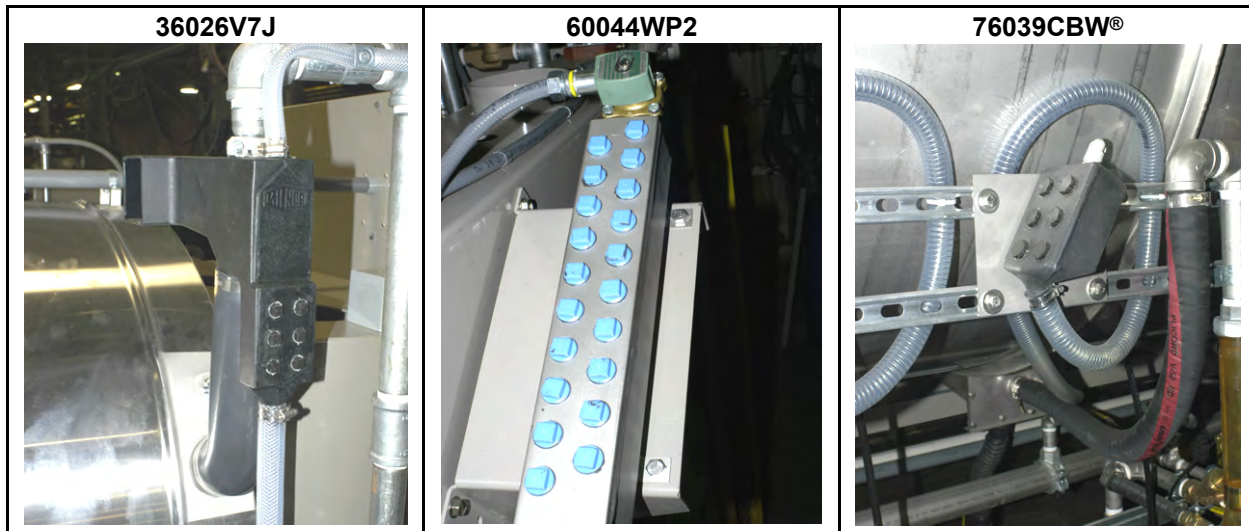

Figure 11. Soap Chute and Optional 5-compartment Supply Injector. These are examples. Your machine can look different.

<p style="text-align: center;">Soap Chute</p>	<p style="text-align: center;">Supply Injector</p>	<p style="text-align: center;">Flush Water Adjustment Components</p>
<p>Legend</p> <p>1 . . . Do not let chemical supplies stay on surfaces.</p> <p>2 . . . Water pressure regulator. See caution statement below.</p> <p>3 . . . Adjustment screw</p> <p>4 . . . Water pressure gauge</p> <p>5 . . . Strainer inside</p>		

3.2.4 Water and Steam Devices

BNWU01.C10 0000351753 A.6 B.21 10/22/21 3:55 PM Released



CAUTION: **Restricted air flow** — can cause incorrect level readings.

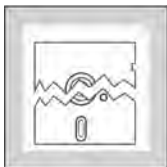

- ▶ Keep the connecting tube or hose free of blockages and leaks.
- ▶ Make sure that the connections are tight.

Figure 12. Air Tube for the Water Level Sensor. These are examples. Your machine can look different.

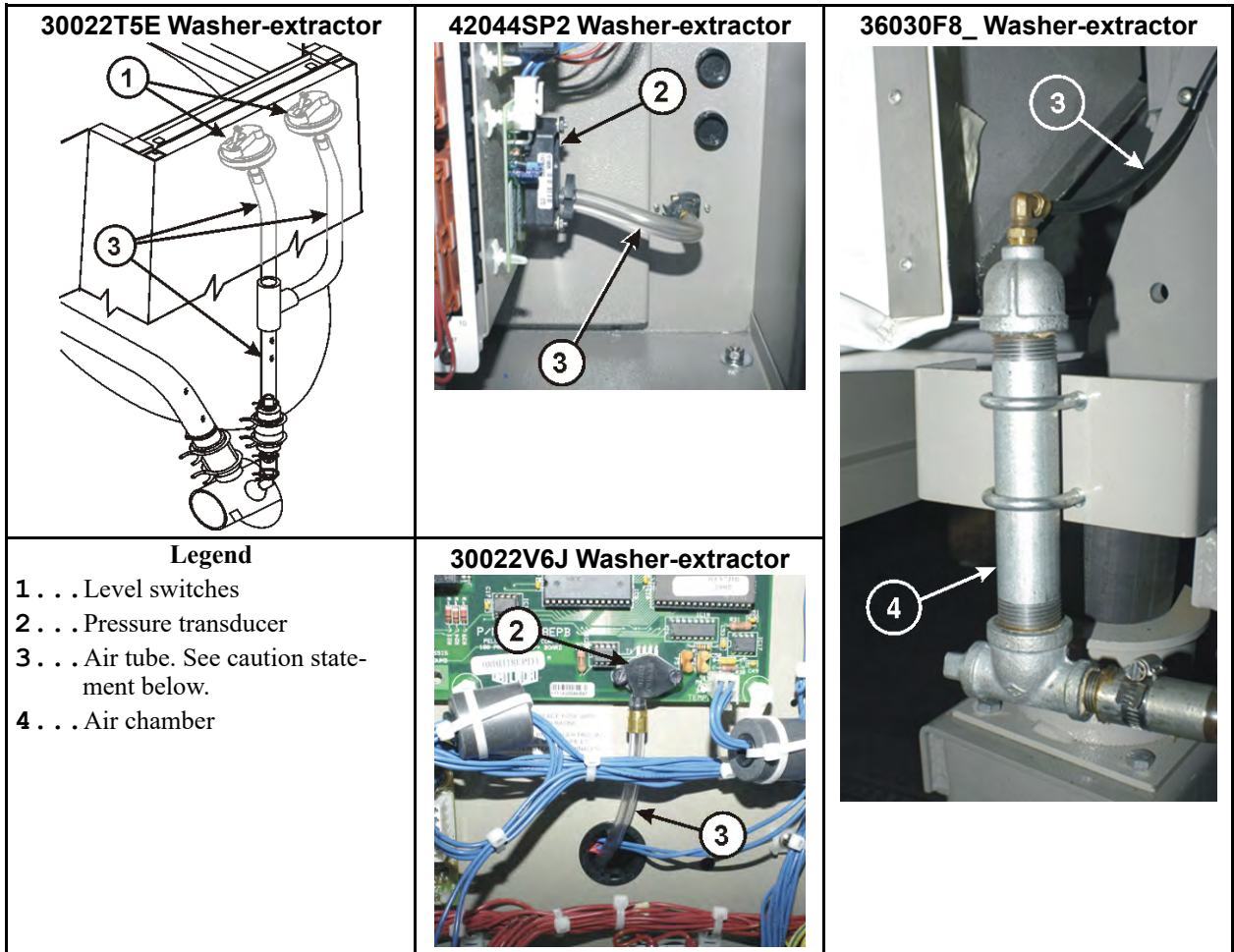
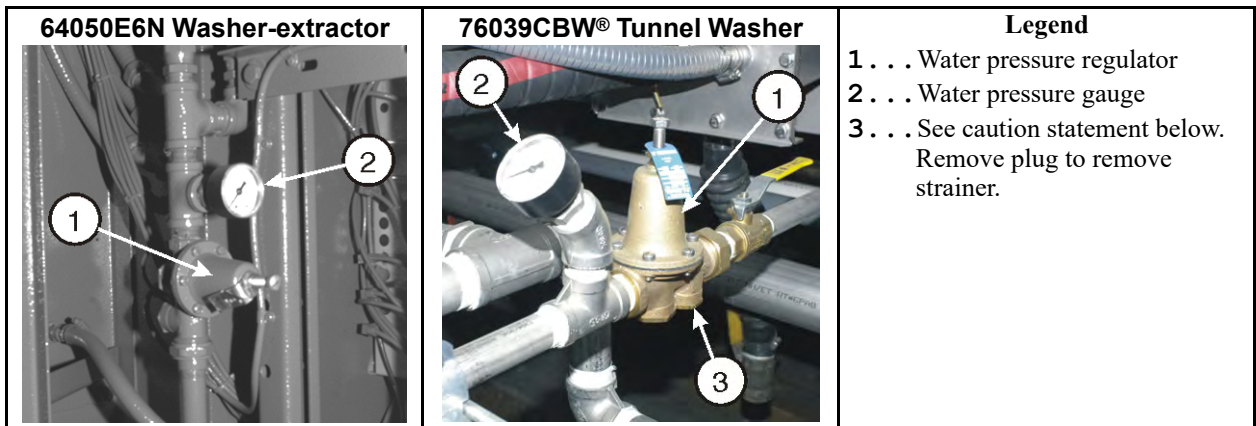

Figure 13. Water Pressure Regulator for Chemical Flush. These are examples. Your machine can look different.





CAUTION: Release of pressurized steam — can severely burn you.



- ▶ Close the external shutoff valve and release remaining pressure before you do maintenance.

Figure 14. Steam Inlet Strainer. These are examples. Your machine can look different.

<p>42044SP2 Washer-extractor</p>	<p>76039CBW® Tunnel Washer</p>	<p>Legend</p> <p>1 . . . Steam strainer. Remove steam pressure before you remove the plug. See warning statement below.</p> <p>2 . . . Steam valve can burn</p>
---	---------------------------------------	--

3.2.5 How to Examine Compressed Air Mechanisms

BNWU01.C04 0000335530 A.6 B.21 A.8 10/14/21 2:00 PM Released



CAUTION: Compressed air pressure — can cause components to fly apart forcefully.



- ▶ Close the external shutoff valve and release remaining pressure before you do maintenance.

Figure 15. Compressed Air Inlet Strainers. These are examples. Your machine can look different.

<p>T-Strainer. Outside machine frame on some models.</p>	<p>T-Strainer. Inside machine frame on some models.</p>	<p>Y-strainer. Used on some models</p>
<p>Legend</p> <p>1 . . . See caution statement below. Remove plug to remove strainer.</p> <p>2 . . . Compressed air in.</p>		

Figure 16. Self-purging Air Line Filter to Remove Moisture and Other Contamination. These are examples. Your machine can look different.

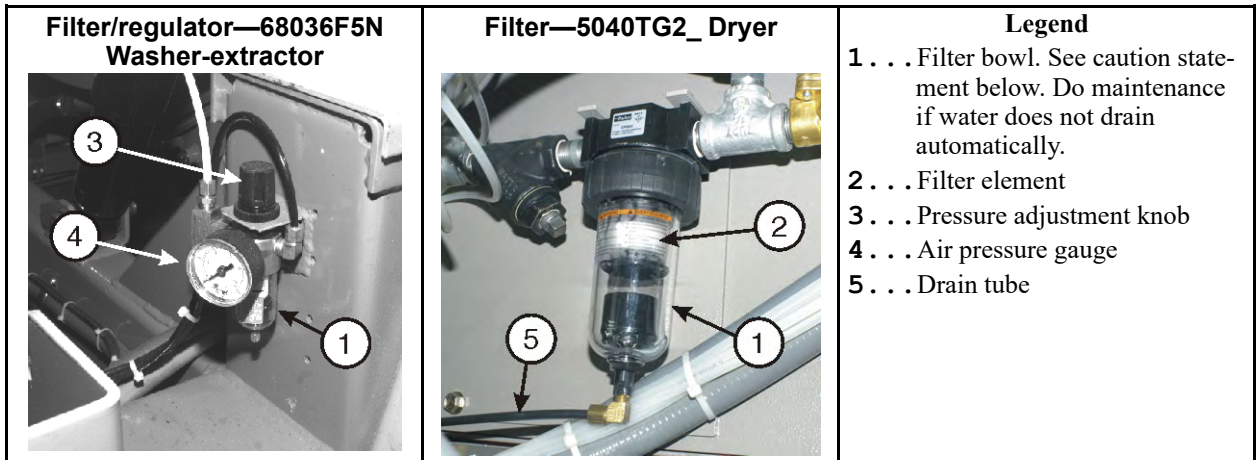

Your machine has one or more mechanisms that use compressed air for movement. [Figure 17, page 30](#) shows some examples. See the related figure in document BNVUUH01. To examine a compressed air mechanism, look at the mechanism and listen to it in operation. **Do not touch the mechanism or put your hand in the machine.** Usually you can see movement directly or on a position indicator. Frequently, you can hear a valve open and close. When a signal from the controller to operate the mechanism occurs, the air pressure must increase sufficiently before movement occurs. When the signal stops, the system must release the compressed air. You can usually hear the sound of the exhaust air for a short time.

When a compressed air mechanism operates correctly, its time of movement is usually less than two seconds. The movement is smooth. It does not shake, change speed, or stop in the middle of travel. A mechanism that does not operate correctly will cause unsatisfactory performance. If the mechanism does not operate correctly and you cannot repair the problem, speak to your dealer or Milnor®. Possible causes are as follows:

- a blockage or a leak in the air tube,
- a worn pilot air valve,
- worn components in the mechanism,
- air pressure supplied to the machine is not sufficient,
- a component used to remove contamination from the air line is clogged,
- a quick exhaust valve or muffler is clogged,
- on machines with an air line lubricator, a malfunction or incorrect adjustment prevents sufficient lubrication.

Figure 17. Compressed Air Mechanisms These are examples. Your machine can look different.

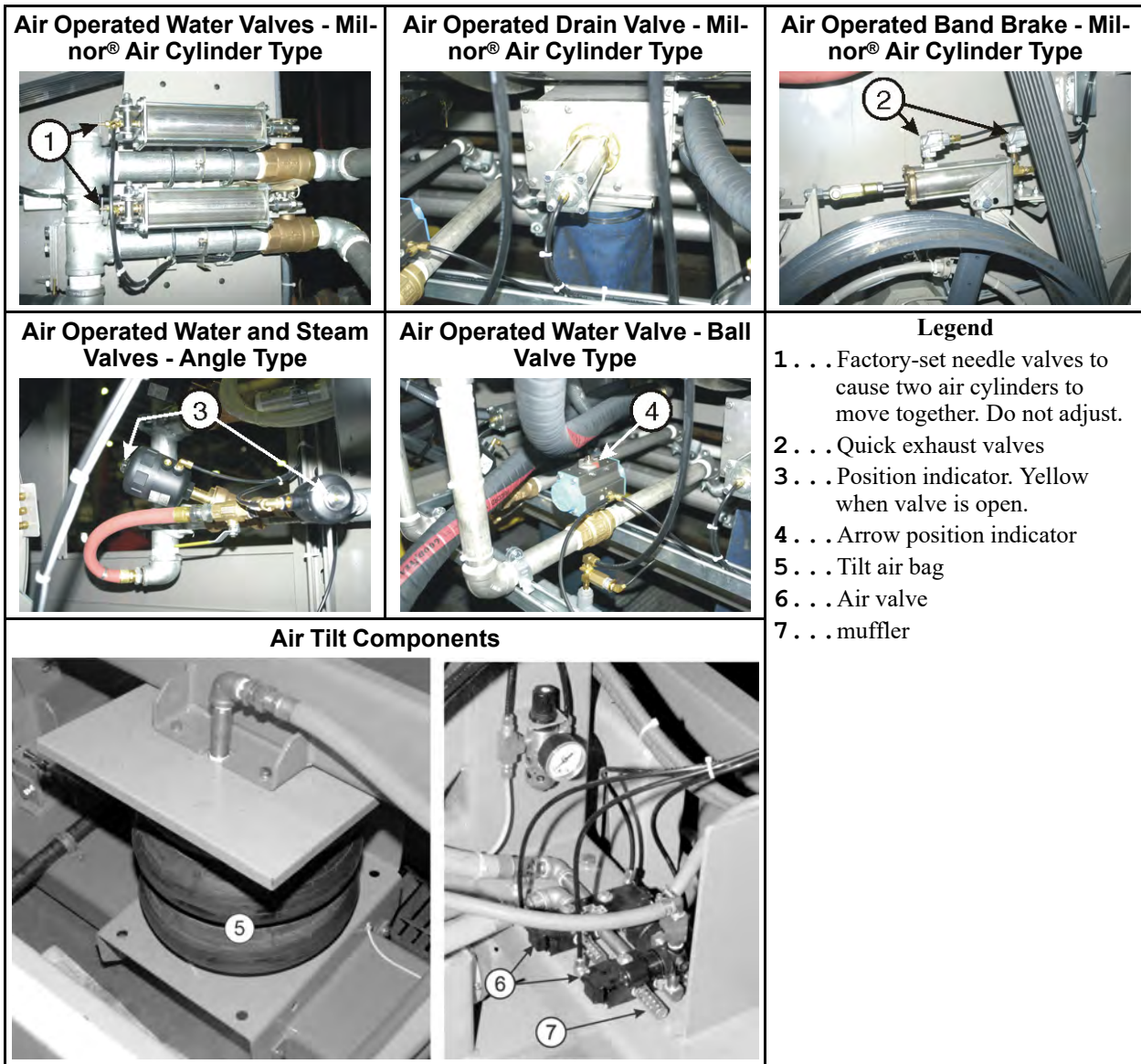

3.2.6 How to Do a Test of Emergency Stop Mechanisms

BNWUJH01.C05 0000335566 A.6 B.21 A.4 2/23/21 11:58 AM Released

This test applies to machines that have one or more stop mechanisms in addition to the Stop button (⓪). Do this test at the intervals given in the maintenance summary.

Definitions:

3-wire circuit a series electrical circuit on a Milnor® machine that must close before the machine can operate. If a switch in the circuit opens, machine movement stops and the operator alarm (a buzzer and a display message) comes on. When you push the start button (①), this closes the 3-wire circuit, which stops the operator alarm and lets the machine operate.

emergency stop mechanism a manual control that opens the 3-wire circuit when a person or object operates the control. Examples - emergency stop button, kick plate, pull cord.

emergency stop button a red push button on a yellow field that locks when a person pushes it (the electrical contacts stay open). It is necessary to turn the button clockwise to unlock it. A machine can have zero or more emergency stop buttons.

kick plate a metal plate on a shuttle conveyor that operates a switch when an object applies sufficient force to the plate. The kick plate is usually the first component of the shuttle to hit an object in the shuttle path. All Milnor® shuttles that go left/right on a path have kick plates on the two sides of the machine.



WARNING: — You can be killed or severely injured if a shuttle strikes you even if you come in contact with the kick plate first.



- ▶ Never do a test of the kick plate when the shuttle operates.

pull cord a wire on a conveyor that operates a switch when a person pulls the wire. All Milnor® free-stand conveyors (a conveyor that is not a component of a larger machine) have pull cords on the two sides of the conveyor.

Do a test of all emergency stop mechanisms on the machine as follows:

1. Apply power to the machine (⏻).
2. Push the start button (①). **Do not cause the machine to operate.** For example, do not start a formula or operate the machine manually. It is not necessary to do the test when the machine operates.
3. Operate an emergency stop mechanism (examples - button, kick plate, pull cord). If the mechanism operates correctly, the operator alarm comes on. Did this occur?
 - Yes—Release the emergency stop mechanism if necessary. For example, if this is an emergency stop button, turn the button clockwise to unlock it. Push the start button (①). Do the test on a different emergency stop mechanism. Continue until you do the test on all emergency stop mechanisms on the machine.
 - No—An electrical component is defective. Shut down the machine. Do not let the machine operate until you correct the problem.

3.3 Maintenance Components—Large Extractors

BNWBUH01.C01 0000336078 A.6 B.15 B.2 6/28/21 11:22 AM Released

3.3.1 Lubricant Maintenance for Grease-filled Drive Bearings

BNWBUH01.C08 0000351843 A.6 B.15 10/26/21 1:32 PM Released

Figure 18. Grease Ports for Grease-only Bearing Assembly

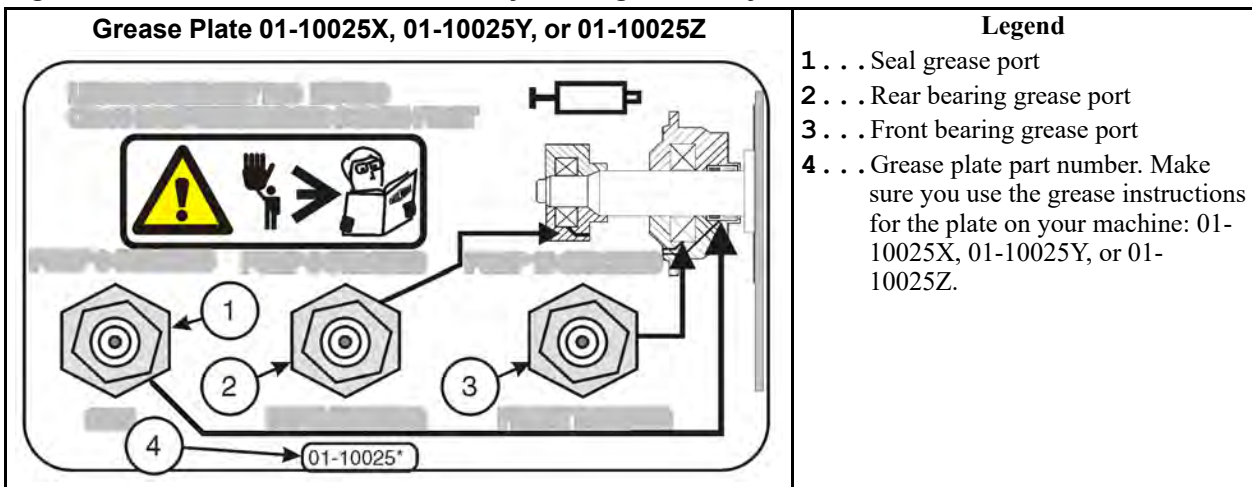

3.3.2 About the Shock Absorbers

BNWBUH01.C04 0000336165 A.6 B.15 A.7 10/13/21 11:58 AM Released

Milnor® washer-extractors with a rubber spring suspension also have shock absorbers. The shock absorbers have a different type of connection than those for automobiles. It is not necessary to replace the shock absorbers at specified intervals. It is only necessary to replace them if there is an indication that they are damaged or very worn.

Examine the shock absorbers at the intervals given in the maintenance summary. It is necessary to replace a shock absorber if you see oil come out from the mechanism (see the figure that follows). This shows that seals are worn. It is also necessary to replace the shock absorber if the rubber in a connector is very worn or missing.

Bad shock absorbers will let the shell move too much when the machine operates. If severe movement occurs and you are not sure of the cause, you can do a test of the shock absorbers as follows:

1. Remove the shock absorber from the machine.
2. With your body weight, compress the length of the shock absorber against a hard surface. A serviceable shock absorber compress slowly. It will also expand slowly to its initial length when you release it. If it compresses or expands quickly, the shock absorber is bad.

Figure 19. Suspension Components on Each Side of Rubber Spring-Hung Washer-extractors

